



# WINDOW AIR CONDITIONER

## USER MANUAL

FOR MODEL:  
4PAC6000  
4PAC8000



Before using your air conditioner, please read this manual carefully and keep it for future reference, along with your receipt.

# CONSUMER PRODUCT INFORMATION

---

For your own records, please attach a copy of your sales receipt to this manual and complete the following:

Model Number: \_\_\_\_\_ Serial Number: \_\_\_\_\_

Purchase Date: \_\_\_\_\_ Store Purchased: \_\_\_\_\_

Installation Date: \_\_\_\_\_ Installation Co.: \_\_\_\_\_

Installer Name: \_\_\_\_\_ Installer Phone No.: \_\_\_\_\_

# CONTENTS

---

SAFETY PRECAUTIONS.....	1
IMPORTANT SAFETY INSTRUCTIONS.....	3
INSTALLATION INSTRUCTIONS.....	4
NORMAL SOUNDS.....	9
AIR CONDITIONER FEATURES.....	9
CARE AND CLEANING.....	12
TROUBLESHOOTING.....	13

This manual provides the information needed for proper use and maintenance of this air conditioner. Basic preventative care can help extend the life of this unit. The “Troubleshooting” section in this manual contains a chart with solutions to the most common problems. Referring to this section may save time and prevent the need for a service call in the event of a problem.

## CAUTION

- Contact an authorized service technician for repair or maintenance of this unit.
- If necessary, contact an installer for installation of this unit.
- The air conditioner is not intended for use by young children without adult supervision. Young children should be supervised to ensure that they do not play with the air conditioner.
- Disabled persons may require assistance with set up.
- If the power cord is to be replaced, replacement work should be performed by authorized personnel only.
- Installation and repair work must be performed in accordance with the national wiring standards by authorized personnel only.
- Do not operate your air conditioner in a wet room such as a bathroom or laundry room.

**NOTE:** All the illustrations in this manual are for explanation purposes only. Unit purchased may be slightly different.

The design and specifications are subject to change without prior notice for product improvement. Contact Consumer Services as 844-4PA-AIRE (844-472-2473) for details.

# SAFETY PRECAUTIONS

## READ SAFETY PRECAUTIONS BEFORE INSTALLATION

To prevent injury to the user or other people and property damage, the following instructions must be followed. Incorrect operation due to ignoring of instructions may cause harm or damage. The seriousness is classified by the following indications.



**THIS SYMBOL INDICATES THAT IGNORING INSTRUCTIONS MAY CAUSE DEATH OR SERIOUS INJURY.**



**THIS SYMBOL INDICATES THAT IGNORING INSTRUCTIONS MAY CAUSE MODERATE INJURY TO YOUR PERSON, OR DAMAGE TO YOUR UNIT OR OTHER PROPERTY.**

**OTHER SYMBOLS:**

**NEVER DO THIS.**

**ALWAYS DO THIS.**

## **WARNINGS**

Plug in power cord properly.	Failure to do so may cause electric shock or fire due to excess heat generation.
<b>DO NOT</b> operate or stop the unit by inserting or pulling out the power plug directly from the wall.	Doing so may cause electric shock or fire due to heat generation.
<b>DO NOT</b> use a damaged power cord.	Doing so may cause electric shock or fire. If the power cord is damaged, it must be replaced by the manufacturer or an authorized service center or a similarly qualified person in order to avoid a hazard.
<b>DO NOT</b> modify power cord length or share the outlet with other appliances.	Doing so may cause electric shock or fire due to heat generation.
<b>DO NOT</b> operate with wet hands or in damp environment.	Doing so may cause electric shock.
<b>DO NOT</b> direct airflow directly at room occupants.	This could cause health issues.
Always ensure effective grounding.	Incorrect grounding may cause electric shock.
<b>DO NOT</b> allow water to run into electric parts.	Doing so may cause failure of machine or electric shock.
Always install circuit breaker and a dedicated power circuit.	Incorrect installation may cause fire and electric shock.
Always unplug the unit if strange sounds, smell or smoke comes from the unit.	Failure to do so may cause fire and electric shock.
<b>DO NOT</b> use the socket if it is loose or damaged.	Doing so may cause fire and electric shock.
<b>DO NOT</b> open the unit during operation.	Doing so may cause electric shock.
<b>DO NOT</b> use firearms near unit.	Doing so may cause fire.
<b>DO NOT</b> use the power cord close to heating appliances.	Doing so may cause fire and electric shock.
<b>DO NOT</b> disassemble, modify, or drill holes into the air conditioner.	Doing so may cause failure and electric shock and void the manufacturer's warranty.
Ventilate room before operating air conditioner if there is a gas leak from another appliance such as a stove.	Failure to do so may cause explosion, fire and burns.
<b>DO NOT</b> use the power cord near flammable gas or combustibles, such as gasoline, benzene, thinner, etc.	Doing so may cause an explosion or fire.

## CAUTIONS

 When removing air filter, <b>DO NOT</b> touch metal parts of the unit.	Doing so may cause an injury.
 <b>DO NOT</b> clean with water.	Water may enter the unit and degrade the insulation, causing an electric shock.
 Ensure proper ventilation, especially in rooms with a stove or other appliances.	Failure to do so may result in an oxygen shortage.
 Unit and circuit breaker/fuse must be switched OFF when cleaning.	Cleaning unit when power is ON may cause fire and electric shock and may cause an injury.
 <b>DO NOT</b> put a pet or house plant where it will be exposed to direct air flow.	This could injure the pet or plant.
 Use <b>ONLY</b> as intended.	This unit is <b>NOT</b> intended to preserve precision devices, food, pets, plants, and art objects. It may cause deterioration of quality, etc.
 Stop operation and close the window in severe storms or hurricanes.	Operation with windows open may cause moisture to enter the room.
 Hold the plug by the head of the power plug when taking it out.	Failure to do so may cause electric shock and damage.
 If unit will not be used for a long period of time, unplug or turn <b>OFF</b> main power switch.	Leaving power on may cause unit failure or fire.
 Do not place obstacles around air-inlets or inside of air-outlet.	Obstacles may cause appliance failure or accident.
 Periodically check installation bracket for damage.	Prolonged exposure to outdoor elements may cause damage to installation bracket, causing unit to fall.
 Always insert filter(s) securely. Clean filter(s) <b>AT LEAST</b> once every two weeks.	Operation without securely installed filters may cause failure. A dirty filter can cause the unit to not run efficiently.
 Use only a soft cloth to clean the unit.	Cleaners or detergents may change the color or scratch the surface of the unit.
 Use caution when unpacking and installing.	Sharp edges could cause injury.
 <b>NEVER</b> drink water drained from air conditioner.	Water from unit contains contaminants and could cause illness.
 <b>DO NOT</b> place heavy objects on the power cord and always ensure that the cord is not compressed.	There is danger of fire or electric shock.
 If water enters the unit's electrical components, turn the unit off at the power outlet and switch off the circuit breaker. Isolate supply by taking the power-plug out and contact a qualified serviced technician.	There is danger of electric shock.

# IMPORTANT SAFETY INSTRUCTIONS

## NOTE:

The power supply cord with this air conditioner contains a current detection device designed to reduce the risk of fire. Please refer to the section "Operation of Current Device" (below) for details. In the event that the power supply cord is damaged, it cannot be repaired. It must be replaced by an authorized repair technician with a cord from the Product Manufacturer.

## WARNING

Avoid fire hazards or electric shock. **DO NOT** use an extension cord or an adapter plug. **DO NOT** remove any prong from the power cord.

Grounding Type  
Wall Receptacle

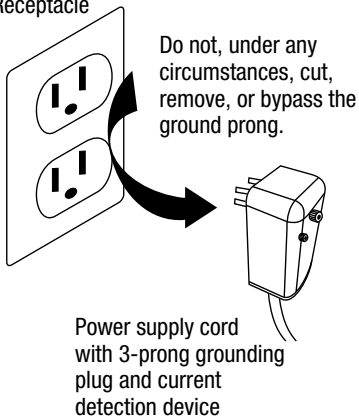

## OPERATION OF CURRENT DEVICE:

The power supply cord contains a current device that senses damage to the power cord. To test your power supply cord, do the following:

1. Plug in the air conditioner.
2. The power supply cord will have TWO buttons on the plug head. Press the TEST button. You will notice a click as the RESET button pops out.
3. Press the RESET button. Again, you will notice a click as the button engages.
4. The power supply cord is now supplying electricity to the unit. (On some products this is also indicated by a light on the plug head.)

## WARNING

FOR YOUR SAFETY: Do not store or use gasoline or other flammable vapors and liquids in the vicinity of this or any other appliances.

## WARNING - PREVENT ACCIDENTS

To reduce the risk of fire, electrical shock, or injury to persons when using your air conditioner, follow basic precautions, including the following:

- Be sure the electrical service is adequate for the model you have chosen. This information can be found on the serial plate, which is located on the side of the cabinet and behind the grille.
- If the air conditioner is to be installed in a window, you will probably want to clean both sides of the glass first. If the window is a triple-track type with a screen panel included, remove the screen completely before installation.
- Be sure the air conditioner has been securely and correctly installed according to the installation instructions in this manual.
- Save this manual for possible future use in removing or installing this unit.
- When handling the air conditioner, be careful to avoid cuts from sharp metal fins on front and rear coils.

## WARNING - ELECTRICAL INFORMATION

The complete electrical rating of your new room air conditioner is stated on the serial plate. Refer to the rating when checking the electrical requirements.

- Be sure the air conditioner is properly grounded. To minimize shock and fire hazards, proper grounding is important. The power cord is equipped with a three-prong grounding plug for protection against shock hazards.
- Your air conditioner must be used in a properly grounded wall receptacle. If the wall receptacle you intend to use is not adequately grounded or protected by a time delay fuse or circuit breaker, have a qualified electrician install the proper receptacle.
- Ensure the receptacle is accessible after the unit installation.
- Do not run air conditioner without side protective cover in place. This could result in mechanical damage within the air conditioner.
- Do not use an extension cord or an adapter plug.

## NOTE:

Do not use the plug to turn the unit on or off.

- Always make sure the RESET button is pushed in for correct operation.
- The power supply must be replaced if it fails reset when either the TEST button is pushed or it cannot be reset.
- If power supply cord is damaged, it cannot be repaired. Please call Consumer Services at 844-472-2473 to assist with replacement.

**NOTE:** This air conditioner is designed to be operated under the following conditions:

Cooling Operation	<b>Outdoor Temp:</b>	64–109°F/18–43°C (64–125°F/18–52°C for special tropical models)
	<b>Indoor Temp:</b>	62–90°F/17–32°C

Performance may be reduced outside of these operating temperatures.

# INSTALLATION INSTRUCTIONS

## **STOP** BEFORE YOU BEGIN

Read these instructions completely and carefully.

**IMPORTANT-** Save these instructions.

**IMPORTANT-** Observe all governing codes and ordinances.

**Note to Installer-** Be sure to leave these instructions with the Consumer.

**Note to Consumer-** Keep these instructions for future reference.

**Skill level-** Installation of this appliance requires basic mechanical skills.

**Completion time-** Approximately 1 hour.

We recommend that two people install this product.

Proper installation is the responsibility of the installer.

Product failure due to improper installation is not covered under the Warranty.

You **MUST** use all supplied parts and use proper installation procedures as described in these instructions when installing this air conditioner.

## **!** WINDOW REQUIREMENTS

Your air conditioner is designed to install in standard double hung windows with opening widths of 23 to 36 inches (584 mm to 914 mm).

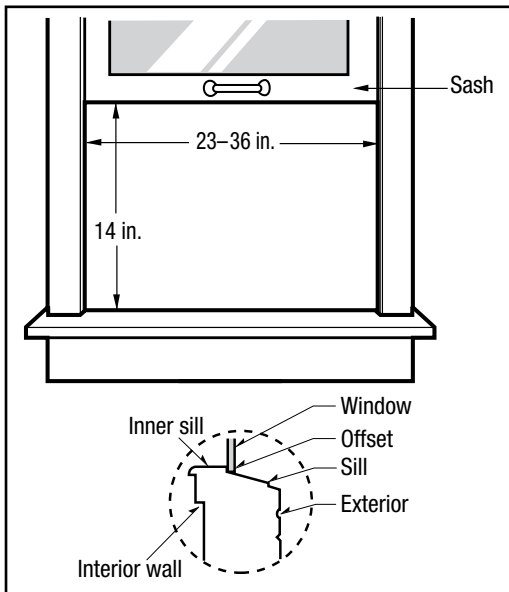

## **!** CAUTION

**DO NOT**, under any circumstances, cut or remove the third (ground) prong from the power cord.

**DO NOT** change the plug on the power cord of the air conditioner.

Aluminum house wiring may present special problems-consult a qualified electrician.

When handling unit, be careful to avoid cuts from sharp metal edges and aluminum fins on front and rear coils.

## TOOLS YOU WILL NEED









- Phillips Screwdriver
- Level

## TOOLS YOU MAY NEED

- Flathead Screwdriver
- Pencil
- Ruler or Tape Measure
- Scissors or Knife

## HARDWARE

Included - packed with the unit.

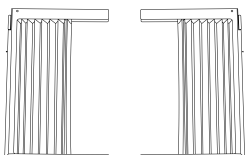
(Included - Packed with the Unit)		
3/4" (or 1/2") Screws		7 pcs
Lock Frame		2 pcs
Sash Lock		1 pc
Window Sash Seal Foam		1 pc
Weather Stripping 10" x 3/4" x 1/12"		5 pcs
3/8" Screws		4 pcs
Top Rail		1 pc
Insulation Panels		2 pcs
Accordion Panels (one left, one right)		1 set

**▶ STEP 1:  
PREPARE THE WINDOW**

Lower sash must open sufficiently to allow a clear vertical opening of 13 inches (330 mm). Side louvers and the rear of the AC must have clear air space to allow enough airflow through the condenser for heat removal. The rear of the unit must be outdoors, not inside a building or garage.

**MOUNTING HARDWARE:**

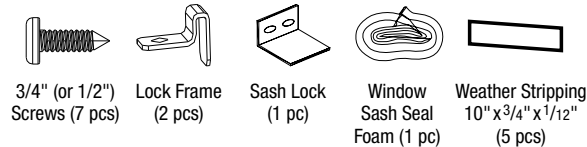

**▶ STEP 2:  
PREPARE AIR CONDITIONER**

- A. Remove the air conditioner from the carton and place on a flat surface.
- B. Remove top rail and insulation panels from the rear of the packaging material as shown in Fig. A. (Energy Star rated units only.)

**TOP RAIL HARDWARE:**

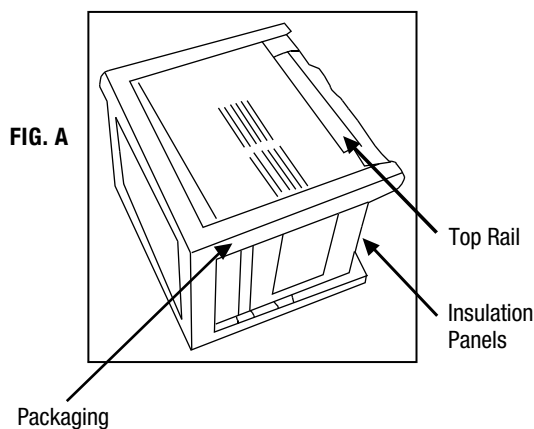
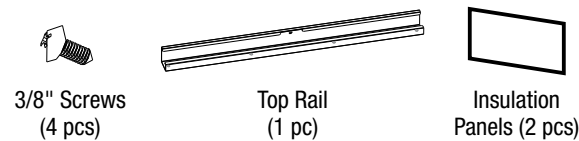

- C. Align the hole in the top rail with those in the top of the unit as shown in Fig. B.

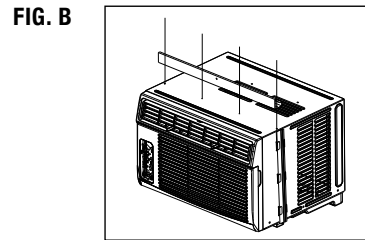

- D. Secure the top rail to the unit with the 3/8" screws as shown in Fig. C.

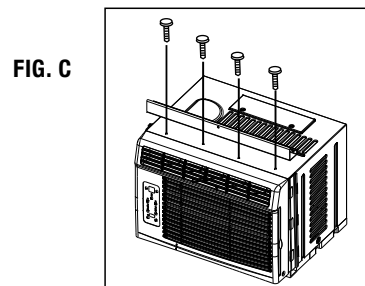

**NOTE:** For safety reasons, all four (4) screws MUST be securely fastened.

**▶ STEP 3:  
INSTALL THE ACCORDION PANELS**

**NOTE:** Top rail and sliding panels on each side are offset to provide the proper pitch of 5/16" to the rear. This is necessary for proper condensed water utilization and drainage. If you are not using the side panels for any reason, this pitch to the rear must be maintained.

- A. Place unit on floor, a bench or a table. Hold the accordion panel in one hand and gently pull back the center to fill the open end. See Fig.1.

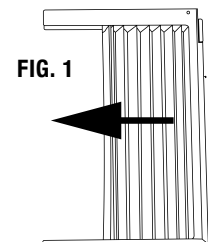

- B. Slide the free end "I" section of the panel directly into the cabinet as shown in Fig. 2. Slide the panel down. Be sure to leave enough space to slip the top and bottom of the frame into the rails on the cabinet.

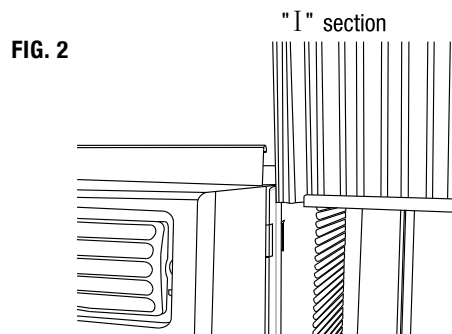



C. Once the panel has been installed on the side of the cabinet, make sure it sits securely inside the frame channel by making slight adjustments. Slide the top and bottom ends of the frame into the top and bottom rails of the cabinet. (Fig. 3)

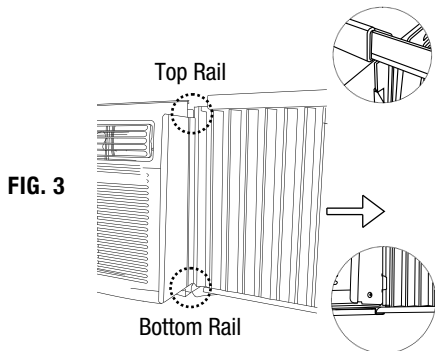

D. Slide the panel all the way in and repeat on the other side. (Fig 4)

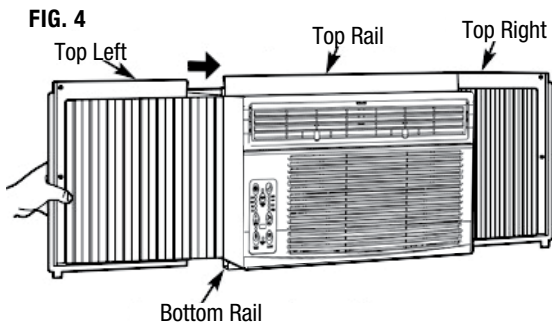

**NOTE:** If storm window blocks AC, see Fig. 15, pg. 8.

**► STEP 4:  
SECURE THE ACCORDION PANELS**

A. Keeping a firm grip on the air conditioner, carefully place the unit into the window opening so the bottom of the air conditioner frame is against the window sill (Fig. 5). Carefully close the window behind the top rail of the unit.

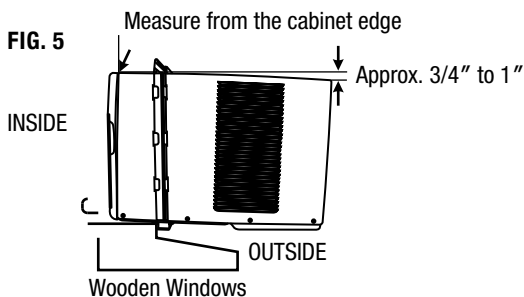

**NOTE:** Check that air conditioner is tilted back approximately 3/4" to 1" (Fig. 5 above) (tilted about 3° to 4° downward to the outside). If, after proper installation, condensation does not drain from the overflow drain hole during normal use, adjust slope.

B. Extend the side panels out against the window frame (Fig. 6).

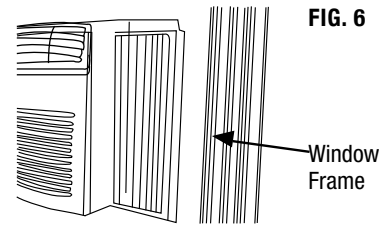

**► STEP 5:  
INSTALL SUPPORT BRACKET**

A. Place the lock frame between the frame extensions and the window sill as shown in Fig. 7. Drive 3/4" (19 mm) or 1/2" (12.7 mm) locking screws through the lock frame and into the sill.

**NOTE:** To prevent window sill from splitting, drill 1/8" (3 mm) pilot holes before driving screws.

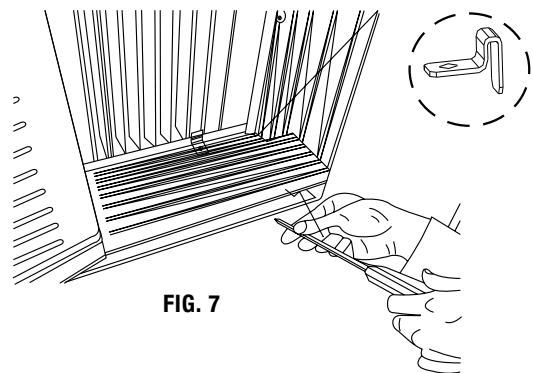

B. Drive 3/4" (19 mm) or 1/2" (12.7 mm) locking screws through frame holes into window sash (Fig. 8).

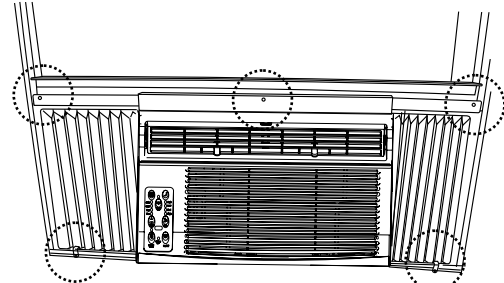

C. To secure lower sash in place, attach right angle sash lock with 3/4" (19 mm) or 1/2" (12.7 mm) screw as shown (Fig. 9).

FIG. 9



D. Cut window sash seal foam and insert it in the space between the upper and lower sashes (Fig. 10).

FIG. 10

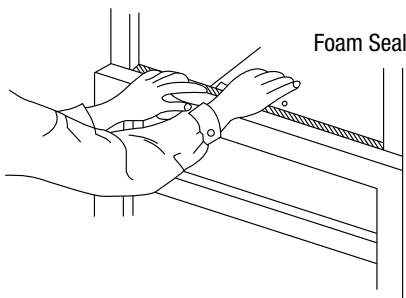

► **STEP 6:**  
**INSTALL INSULATION PANELS**

In order to minimize air leaks and ensure optimal insulation, it is necessary to install the included Insulation panels to the accordion panels. Follow the 4 steps in these instructions:

**STEP 6.1:** After the unit is installed in the window, measure the inner width of one of the accordion panels as shown in Fig. 11.

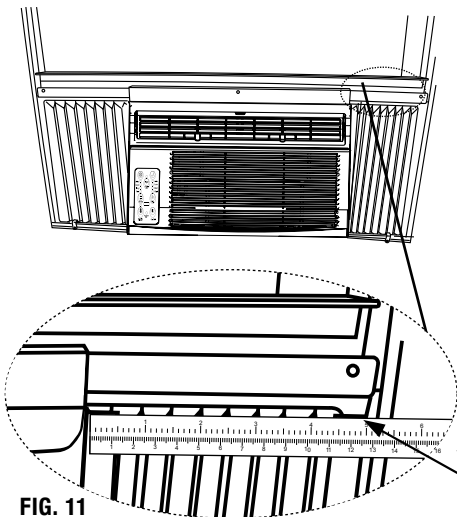
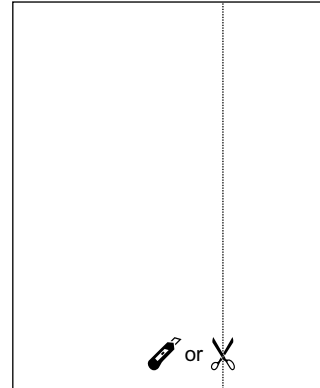

FIG. 11

Measure the inner width of one of the accordion panels.

**STEP 6.2:** Mark a line on one of the provided insulation panels, matching the measured width in Step 6.1; Cut the insulation panel along the line (Fig. 12).

FIG. 12



**STEP 6.3:** Slide the insulation panel you just cut into the accordion panel. The side of the insulation panel with the pattern on it should face indoors. (Fig. 13)

FIG. 13

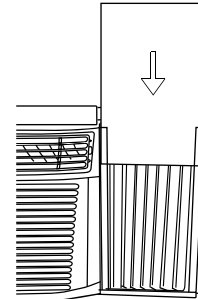

**STEP 6.4:** Repeat on other side with the second insulation panel.

**► STEP 7:  
INSTALL WEATHER STRIPPING**

In order to minimize air leaks between the room air conditioner and the window opening, install weather stripping into any gaps as you see necessary by trimming the weather stripping to the desired length, peeling off the protective backing and filling these gaps. (Fig. 14)

FIG. 14

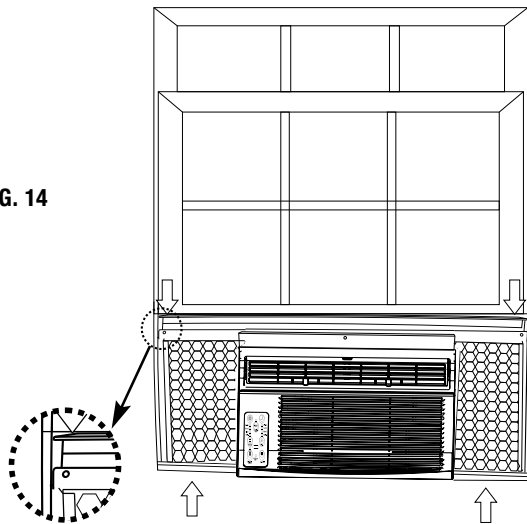

**► IF AC IS BLOCKED BY A  
STORM WINDOW**

Add wood as shown in Fig.15, or remove storm window before air conditioner is installed.

If storm window frame must remain, be sure the drain holes or slots are not caulked or painted shut. Accumulated rain water or condensation must be allowed to drain out.

FIG. 15

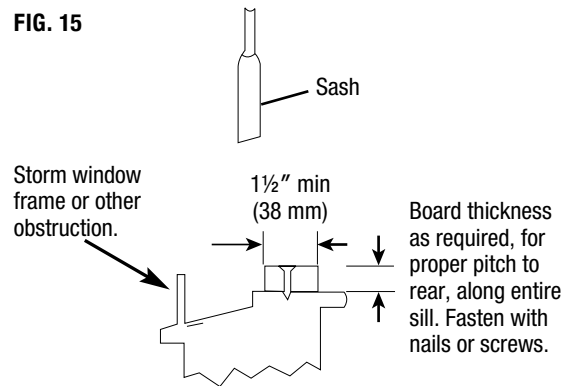

**► REMOVING AC FROM WINDOW**

- Turn AC off, and disconnect power cord.
- Remove sash seal from between windows, and unscrew safety sash lock.
- Remove screws installed through frame and frame-lock.
- Remove the Insulation Panels and close (slide) side accordion panels into frame.
- Keeping a firm grip on air conditioner, raise sash and carefully remove.
- Be careful not to spill any remaining water while lifting unit from window. Store parts WITH air conditioner.

# NORMAL SOUNDS

**HIGH PITCHED CHATTER**  
High efficiency compressors may have a high pitched chatter during the cooling cycle.

**VIBRATION**  
Unit may vibrate and make noise because of poor wall or window construction or incorrect installation. This DOES NOT indicate a defective unit.

**PINGING OR SWITCHING**  
Droplets of water hitting condenser during normal operation may cause “pinging” or “switching” sounds.

**SOUND OF RUSHING AIR**  
At the front of the unit, the sound of rushing air being moved by the fan may be heard.

**GURGLE/HISS**  
“Gurgling” or “hissing” noise may be heard due to refrigerant passing through evaporator during normal operation.

**NOTE:** All of the pictures in this manual are for explanatory purposes only. The actual shape/look of the air conditioner purchased may be slightly different, but the operations and functions are similar.

# AIR CONDITIONER FEATURES

Thoroughly familiarize yourself with the control panel shown below and all of its functions. Afterwards, follow the symbol for the functions you desire BEFORE operating the unit. This unit can be controlled by the unit control or with the remote control.

Displays Temp. or the Time or Error Codes

Adjusts Temp. or Time

Adjusts Temp. or Time

“FOLLOW ME” Indicator

Sets Mode

Sleep Mode

Activates Timer

Turns Unit On or Off

Auto

Low

Med

High

Auto

Cool

Dry

Fan

Follow Me

On

Off

Energy Saver

Timer

Sleep

Check Filter

Check Filter

Remote Signal Receptor

Set Fan Speed

Energy Saver Mode

Check Filter Reset Button

Adjusts Temp. or Time

## ► TO TURN UNIT ON OR OFF:

Press ON/OFF button to turn the unit on or off.

**NOTE:** The unit will automatically initiate the Energy Saver function under COOL, DRY and AUTO (only AUTO-COOLING and AUTO-FAN modes).

## ► TO CHANGE TEMPERATURE SETTING:

Press UP/DOWN button to change the temperature setting.

**NOTE:** Press or hold either UP () or DOWN () button until the desired temperature is seen on the display. The temperature will be automatically maintained anywhere between 62°F (17°C) and 86°F (30°C). If you want the display to read the actual room temperature, see “To Operate on Fan Only” section.

## ► TO ADJUST FAN SPEEDS:

Press to select the Fan Speed in four steps: Auto, Low, Med or High. Each time the button is pressed, the fan speed is shifted. In DRY mode, the fan speed is controlled at Low automatically.

### ► SLEEP FEATURE:

Press  SLEEP button to initiate the SLEEP mode. In this mode, the selected temperature will increase by 2°F (1°C) 30 minutes after the mode is selected. The temperature will then increase (cooling) or decrease (units with heating only) by another 2°F (1°C) after an additional 30 minutes. This new temperature will be maintained for 6 hours before it returns to the originally selected temperature. This ends the SLEEP mode and the unit will continue to operate as originally programmed. The SLEEP mode program can be canceled at any time during operation by pressing the SLEEP button again.

### ► CHECK FILTER FEATURE:

Press  CHECK FILTER button to initiate this feature. This feature is a reminder to clean the Air Filter for more efficient operation. The LED (light) will illuminate after 250 hours of operation. To reset after cleaning the filter, press the CHECK FILTER button and the light will go off.

### ► ENERGY SAVER FEATURE:

Press  ENERGY SAVER button to initiate this function. This function is available on COOL, DRY and AUTO (only AUTO-COOLING and AUTO-FAN) modes. In this mode, the fan will continue to run for 3 minutes after the compressor shuts off. The fan then cycles on for 2 minutes, at 10 minute intervals, until the room temperature is above the set temperature, at which time the compressor turns back on and cooling starts.

### ► FOLLOW ME FEATURE:

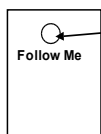

**This feature can ONLY be activated from the remote control. The remote control serves as a remote thermostat allowing for precise temperature control at its location.**

To activate the Follow Me feature, point the remote control towards the unit and press the FOLLOW ME button. The remote displays the actual temperature at its location. The remote control will send this signal to the air conditioner every 3 minutes until the FOLLOW ME button is pressed again. If the unit does not receive the Follow Me signal during any 7 minute interval, the unit will beep to indicate use of the Follow Me feature has ended. The actual temperature can be displayed at the unit by pressing the FAN only mode. When in the COOL mode, the unit display indicates the set temperature.

### ► TO SELECT THE OPERATING MODE:

To choose operating mode, press the  MODE button. Each time you press the button, a mode is selected in a sequence that goes from AUTO, COOL, DRY and FAN. The indicator light will be illuminated and remain on once the mode is selected. **The unit will automatically initiate the Energy Saver function under COOL, DRY, and AUTO (only AUTO-COOLING and AUTO-FAN) modes.**

### TO OPERATE ON AUTO FEATURE:

When you set the air conditioner in AUTO mode, it will automatically select cooling or fan only operation depending on what temperature you have selected and the room temperature. The air conditioner will control room temperature automatically around the temperature you set. **In this mode, the fan speed cannot be adjusted.** It starts automatically at a speed according to the room temperature. If the room does not get too warm, it will stay at a "Low" speed.

### TO OPERATE ON FAN ONLY:

Use this function () only when cooling is not desired, such as for room air circulation or to exhaust stale air. You can choose any fan speed you prefer. During this function, the display will show the actual room temperature, not the set temperature as in the cooling mode. Temperature cannot be adjusted in the FAN only mode.

### TO OPERATE ON DRY MODE:

In this mode, the air conditioner will reduce air humidity. If the space is a closed or sealed area, some degree of cooling will continue.

### ► TIMER: AUTO START/STOP FEATURE:

- When the unit is on or off, first press  TIMER button. The TIMER ON indicator light illuminates. It indicates the Auto Start program is initiated.
- When the time of TIMER ON is displayed, if you press the TIMER button again, the TIMER OFF indicator light illuminates. It indicates the Auto Stop program is initiated.
- Press or hold the UP or DOWN button to change the Auto time by 0.5 hour increments, up to 10 hours, then by 1 hour increments, up to 24 hours. The control will count down the time remaining until start.
- The selected time will register in 5 seconds and the system will automatically revert back to display the previous temperature setting or the room temperature (depending on whether the unit is powered on or off and the mode it is in).
- Turning the unit ON or OFF at any time or adjusting the timer setting to 0.0 will cancel the Auto Start/Stop program.

**A NOTE ABOUT THE TIMER:** When you set the timer, the unit will only go on once and off once. If you want the air conditioner to cycle on and off based on desired room temperature, you do not need to set the timer. Instead, set your desired temperature and the unit will cycle on and off based on that temperature setting.

### ► DISPLAY:

Shows the set temperature in °F or °C and the Auto-timer settings. While on FAN only mode, it shows the room temperature.



### ERROR CODES:

**AS - Room Temperature Sensor Error** - Unplug the unit and plug it back in. If error repeats, call Consumer Services at 844-472-2473.

**HS - Electric Heating Sensor Error** - Unplug the unit and plug it back in. If error repeats, call Consumer Services at 844-472-2473.

- - **Evaporator Temperature Sensor Error** - Unplug the unit and plug it back in. If error repeats, call Consumer Services at 844-472-2473.

**NOTE:** If an error code occurs in Fan only mode, the unit will display “LO” (loose connection) or “HI” (short circuit).

### ↳ NOTE:

If the unit breaks off unexpectedly due to power being cut, it will restart with the previous function setting automatically when the power resumes.

### ► AIR DIRECTIONAL LOUVERS:

Use the 4-way directional louvers to direct the air flow up or down and left or right throughout the room as needed. Pivot horizontal louvers until the desired up/down direction is obtained.

Move the levers from side to side until the desired Left/Right direction is obtained.

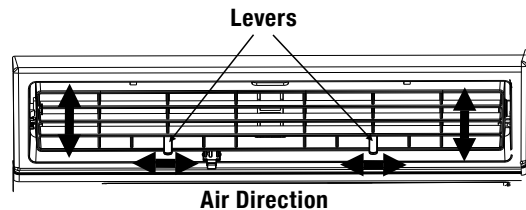

### ► ADDITIONAL THINGS YOU SHOULD KNOW:

- The Cool circuit has an automatic 3 minute time-delayed start if the unit is turned off and on quickly. After unit is turned off, leave unit off for a minimum of 3 minutes before attempting to turn back on. This prevents overheating of the compressor and possible circuit breaker tripping. The fan will continue to run during this time.
- The control is capable of displaying temperature in degrees Fahrenheit or degrees Celsius. To convert from one to the other, press and hold the Up and Down Temp/Timer buttons at the same time for 3 seconds.

# CARE AND CLEANING

## ⚠ CAUTION

Clean air conditioner occasionally to keep it looking and operating like new.  
**Be sure to unplug the unit before cleaning to prevent shock or fire hazards.**

### ► AIR FILTER CLEANING

The air filter should be cleaned at least every two weeks or as necessary. Trapped particles in the filter can build up and cause an accumulation of frost on the cooling coils.

- Open the front panel.
- Grasp the filter by the center and pull up and out.
- Wash the filter using liquid dish-washing detergent and warm water. Rinse filter thoroughly.
- Gently shake excess water from the filter. Be sure the filter is thoroughly dry before replacing.
- As an alternative to washing the filter, vacuum the filter clean.

**NOTE:** Never use hot water over 104°F (40°C) to clean the air filter. Never attempt to operate the unit without the air filter.

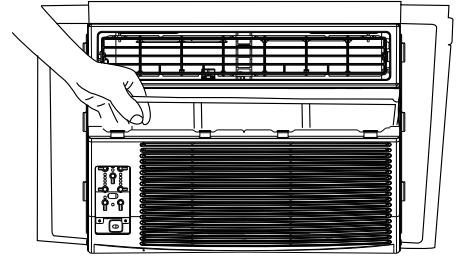

### ► CABINET CLEANING

- Be sure to unplug the air conditioner to prevent shock or fire hazard. The cabinet and front may be dusted with an oil-free cloth or with a cloth dampened in a solution of warm water and mild liquid dish-washing detergent. Rinse thoroughly and wipe dry.
- Never use harsh cleaners, wax or polish on the cabinet front.
- Be sure to wring excess water from the cloth before wiping the controls. Excess water in or around the controls may cause damage to the air conditioner.
- Plug in air conditioner after unit has dried completely.

### ► WINTER STORAGE

If air conditioner will be stored during the winter, remove it carefully from the window according to the installation instructions. Cover it with plastic or return it to the original carton.

**ALWAYS STORE UNIT IN AN UPRIGHT POSITION AND IN A COOL, DRY LOCATION.**

# TROUBLESHOOTING

**BEFORE CALLING FOR SERVICE, PLEASE REVIEW THE CHART BELOW**

ISSUE	POSSIBLE CAUSES
<p><b>AIR CONDITIONER NOT COOLING ROOM, OR NOT BLOWING COLD AIR</b></p>	<ul style="list-style-type: none"> <li>• Be sure unit is not too large or too small for the area of the room.</li> <li>• Verify that all doors, windows, curtains and any other openings are closed. Verify nothing is obstructing the front grille of unit, such as curtains, etc.</li> <li>• Allow enough time for room to cool, especially if outside temp is very high.</li> <li>• Check that the filter is not dirty and louvers are open all the way and blowing in the desired direction.</li> <li>• Check that unit is set to COOL mode and that temperature is down enough (but not too low).</li> <li>• If unit is near a heat source, such as a stove, etc., relocate unit.</li> <li>• If air coming from unit is cool to the touch, then unit is working properly; please double check the first three bullet points above.</li> <li>• If using Follow Me remote feature, move remote away from unit.</li> <li>• Temperature sensor behind air filter touching cold coil. These two elements should not be touching. Carefully straighten tube away from coil.</li> <li>• Unplug unit for at least 5 minutes. Follow Reset instructions on plug.</li> </ul>
<p><b>AIR CONDITIONER COOLING BUT ROOM IS TOO WARM - ICE FORMING ON COOLING COIL BEHIND DECORATIVE FRONT</b></p>	<ul style="list-style-type: none"> <li>• Outdoor temperature is below 64°F (18°C). To defrost the coil, set to FAN only mode.</li> <li>• Air filter may be dirty. Clean filter. Refer to Care and Cleaning section. To defrost, set to FAN only mode.</li> <li>• Thermostat is set too cold for night-time cooling. To defrost the coil, set to FAN only mode. Then, set temperature to a higher setting.</li> </ul>
<p><b>AIR CONDITIONER CYCLING ON AND OFF TOO FREQUENTLY OR NOT ENOUGH</b></p>	<ul style="list-style-type: none"> <li>• Be sure unit is not too large or too small for the area of the room.</li> <li>• Remove grille and make sure the temperature sensor is not too close to the coils. These two elements should not be touching. Carefully straighten tube away from coil.</li> <li>• Make sure nothing is blocking the grille or side vents.</li> <li>• Make sure there is no dirt or debris inside the unit or on the filter.</li> </ul>
<p><b>UNIT WILL NOT TURN ON</b></p>	<ul style="list-style-type: none"> <li>• Reset circuit breaker. Make sure there are not too many items (i.e. lamps, TV's, etc.) working off the same breaker.</li> <li>• Check plug connection.</li> <li>• If plug is operating on an on/off switch, be sure that the switch is 'on'.</li> <li>• Try plugging unit into another outlet.</li> <li>• Unplug unit for at least 5 minutes. Follow Reset instructions on plug.</li> </ul>
<p><b>UNIT BLOWS FUSES OR POPS CIRCUIT BREAKER</b></p>	<ul style="list-style-type: none"> <li>• Make sure there are enough available amps on the circuit for the air conditioner.</li> <li>• Large units which run on a 230v will require a dedicated 20 or 30 amp circuit.</li> </ul>
<p><b>AIR CONDITIONER IS MAKING NOISES</b></p>	<ul style="list-style-type: none"> <li>• Check to be sure the unit is free from debris such as leaves, sticks, etc. Verify nothing is obstructing the unit.</li> <li>• Check the fan blade for cracks or chips.</li> <li>• Make sure the unit is properly and securely mounted inside the window or wall.</li> <li>• Clean the air filter.</li> </ul>
<p><b>WATER PUDDLES INSIDE UNIT OR IS COMING INTO ROOM</b></p>	<ul style="list-style-type: none"> <li>• Adjust the slope of the unit so that it drains downward toward the exterior of the home. (See Installation Instructions.)</li> <li>• Make sure that there is no debris blocking the drainage area of the unit.</li> </ul>
<p><b>WATER DRIPPING OUTSIDE</b></p>	<ul style="list-style-type: none"> <li>• Unit is removing a large quantity of moisture from a humid room. This is normal during excessively humid days.</li> </ul>
<p><b>REMOTE SENSING / FOLLOW ME DEACTIVATING PREMATURELY</b></p>	<ul style="list-style-type: none"> <li>• Remote control not located within range. Place remote control within 20 ft and 180° radius of the front of the unit.</li> <li>• Remote control signal obstructed. Remove obstruction.</li> </ul>

## NOTE

A highly recommended troubleshoot for any issue in general consists of turning off unit and unplugging for 5 minutes. It is also recommended to try another wall outlet. For further assistance, contact Consumer Services at 844-472-2473.







The design and specifications are subject to change without prior notice for product improvement. Consult with the sales agency or manufacturer for details.

**Distributed by:**



Perfect Aire, LLC  
5151 Belt Line Rd.  
Suite 878  
Dallas, TX 75254

**844-4PA-AIRE | 844-472-2473**  
**[www.perfectaire.us](http://www.perfectaire.us)**

PA/User\_4PAC6000\_4PAC8000/10162017

Specification and performance data is subject to change without notice.

Printed in China