

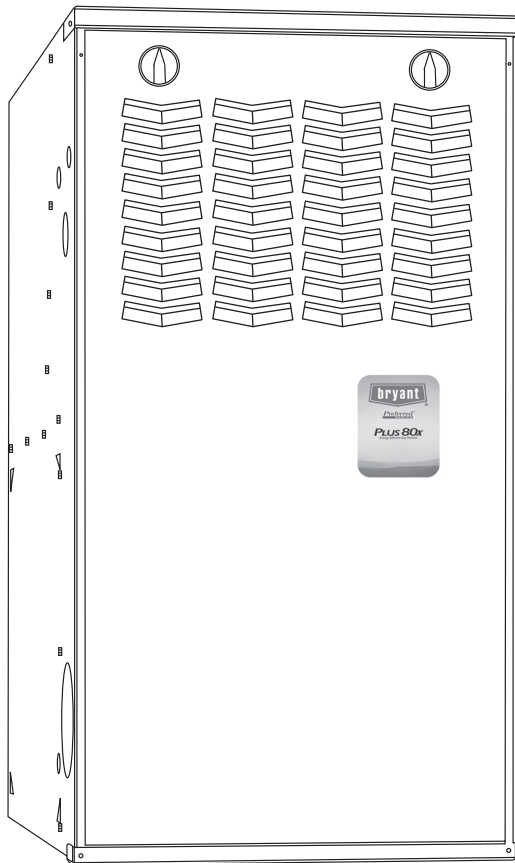

Product Data



A10256

THE BRYANT *Plus 80x* GAS FURNACE

The *Plus 80x* 4-Way Multipoise Gas Furnace offers outstanding features in an 80% AFUE furnace.

Features include: an ECM motor which enhances SEER performance up to 1.5 points*, fault code storage, and more. The *Plus 80x* is very quiet thanks to a new combustion design that eliminates noise, rather than just muffle or box it in. Applications are easy with 4-way multipoise design, through-the-furnace downflow venting, 13 different venting options, and an overall design for easy service access. An inner blower door is provided for tighter sealing in sensitive applications. The 313JBV is approved for use in Low NOx Air Quality Management Districts.

STANDARD FEATURES

- ECM blower motor included
- Noise elimination combustion system
- Cabinet air leakage less than 2.0% at 1.0 in. W.C. and cabinet air leakage less than 1.4% at 0.5 in. W.C. when tested in accordance with ASHRAE standard 193
- Four-position furnace: Upflow, Horizontal Right, Horizontal Left, Downflow
Thirteen different vent options
- Compact design only 33-1/3 in. (847 mm) tall
- Microprocessor based “smart” control center
Adjustable heating air temperature rise/adjustable cooling airflow
Enhanced diagnostics with LED and reflective sight glass, non-volatile fault code memory, and self-test feature
On-board fuse for transformer protection
- Patented blocked vent safeguard to ensure proper furnace venting
- Insulated blower compartment
- HYBRID HEAT® Dual Fuel System compatible
- Perfect Light™ Igniter
- Residential installations eligible for consumer financing through the Comfort Credit Program
- All models are chimney friendly when used with accessory vent kit

*As compared to the Air Conditioning Heating and Refrigeration Institute's standard coil-only rating when paired with selected evaporator coils.

DIMENSIONS

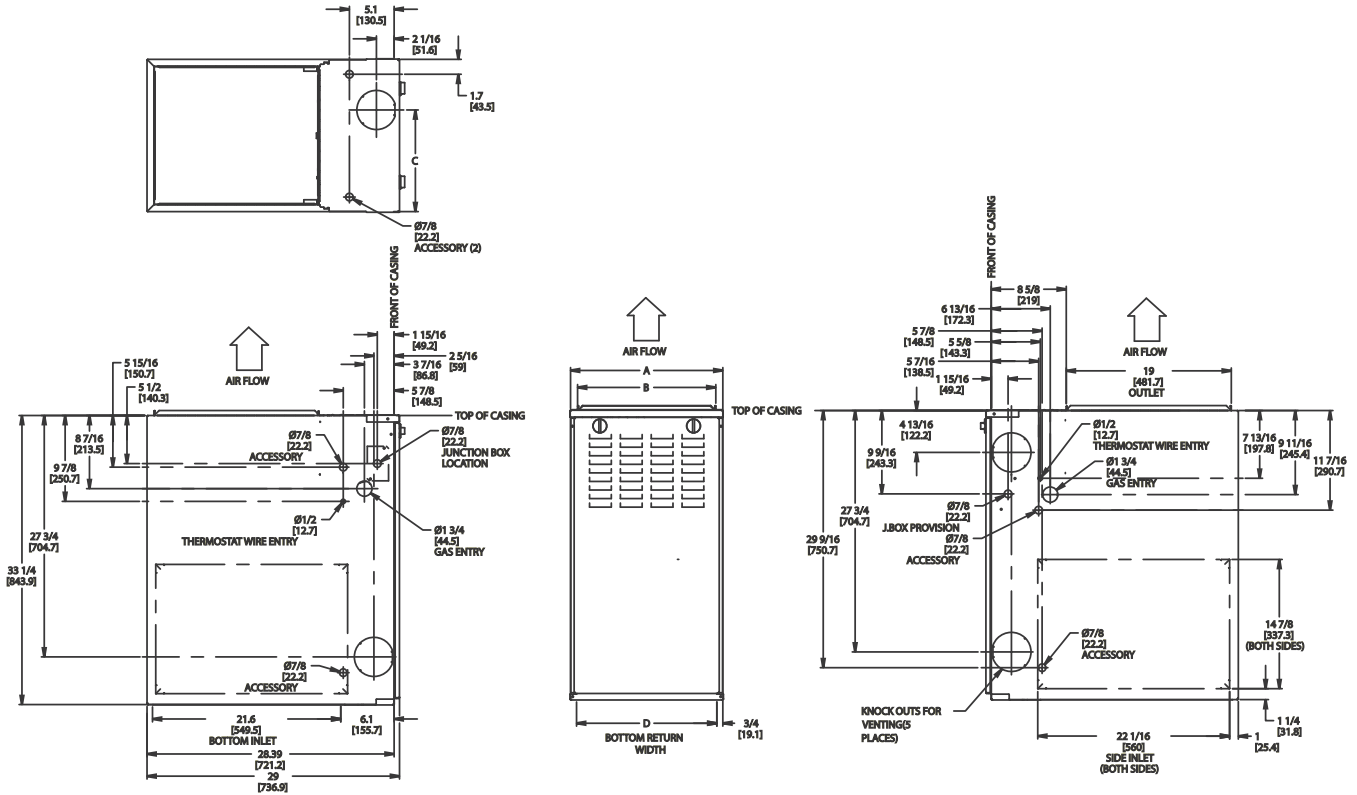

A10290

NOTES:

1. Two additional 7/8-in. (22 mm) diameter holes are located in the top plate.
2. Minimum return-air openings at furnace, based on metal duct. If flex duct is used, see flex duct manufacturer's recommendations for equivalent diameters.
 - a. For 800 CFM—16-in. (406 mm) round or 14 1/2 x 12-in. (368 x 305 mm) rectangle.
 - b. For 1200 CFM—20-in. (508 mm) round or 14 1/2 x 19 1/2-in. (368 x 495 mm) rectangle.
 - c. For 1600 CFM—22-in. (559 mm) round or 14 1/2 x 22 1/16-in. (368 x 560mm) rectangle.
 - d. For airflow requirements above 1800 CFM, see Air Delivery table in Product Data literature for specific use of single side inlets. The use of both side inlets, a combination of 1 side and the bottom, or the bottom only will ensure adequate return air openings for airflow requirements above 1800 CFM.

FURNACE SIZE	A CABINET WIDTH	B OUTLET WIDTH	C TOP AND BOTTOM FLUE COLLAR	D BOTTOM INLET WIDTH	VENT CONNECTION SIZE	SHIP WT. LB. (KG)	ACCESSORY FILTER MEDIA CABINET SIZE IN. (MM)
036045	14-3/16 (360)	12-9/16 (319)	9-5/16 (237)	12-11/16 (322)	4 (102)	104 (47)	16 (406)
036070	17-1/2 (445)	15-7/8 (403)	11-9/16 (294)	16 (406)	4 (102)	126 (57)	16 (406)
048070	17-1/2 (445)	15-7/8 (403)	11-9/16 (294)	16 (406)	4 (102)	126 (57)	16 (406)
042090	17-1/2 (445)	15-7/8 (403)	11-9/16 (294)	16 (406)	4 (102)	126 (57)	16 (406)
048090	21 (533)	19-3/8 (492)	13-5/16 (338)	19-1/2 (495)	4 (102)	140 (64)	20 (508)
060090	21 (533)	19-3/8 (492)	13-5/16 (338)	19-1/2 (495)	4 (102)	140 (64)	20 (508)
060110	21 (533)	19-3/8 (492)	13-5/16 (338)	19-1/2 (495)	4 (102)	152 (69)	20 (508)
060135	24-1/2 (622)	22-7/8 (581)	15-1/16 (383)	23 (584)	4 (102)*	163 (74)	24 (610)

*135 size furnace requires a 5 or 6-in. (127 or 152 mm) vent. Use a vent adapter between furnace and vent stack. See Installation Instructions for complete installation requirements.

⚠ WARNING

**FIRE, EXPLOSION,
ASPHYXIATION HAZARD**

Improper adjustment, alteration, service, maintenance, or installation can cause serious injury or death.

Read and follow instructions and precautions in User's Information Manual provided with this furnace. Installation and service must be performed by a qualified service agency or the gas supplier.

⚠ CAUTION

Check entire gas assembly for leaks after lighting this appliance.

INSTALLATION

1. This furnace must be installed in accordance with the manufacturer's instructions and local codes. In the absence of local codes, follow the National Fuel Gas Code ANSI Z223.1 / NFPA54 or CSA B-149, 1 Gas Installation Code.
2. This furnace must be installed so there are provisions for combustion and ventilation air. See manufacturer's installation information provided with this appliance.

OPERATION

This furnace is equipped with manual reset limit switch(es) in burner compartment to protect against overheat conditions that can result from inadequate combustion air supply or blocked vent conditions.

1. Do not bypass limit switches.
2. If a limit opens, call a qualified serviceman to correct the condition and reset limit switch.

INSTALLATION

MINIMUM INCHES CLEARANCE TO COMBUSTIBLE CONSTRUCTION

This forced air furnace is equipped for use with natural gas at altitudes 0 - 10,000 ft (0 - 3,050m). An accessory kit, supplied by the manufacturer, shall be used to convert to propane gas use or may be required for some natural gas applications. This furnace is for indoor installation in a building constructed on site. This furnace may be installed on combustible flooring in alcove or closet at minimum clearance as indicated by the diagram from combustible material. This furnace may be used with a Type B-1 Vent and may be vented in common with other gas fired appliances.

This furnace is approved for UPFLOW, DOWNFLOW, and HORIZONTAL installations.

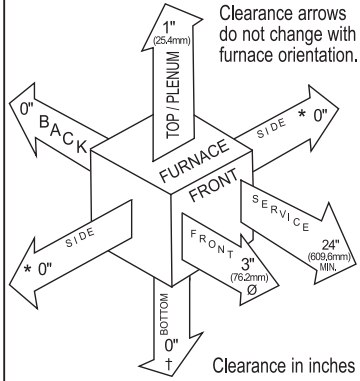

Vent Clearance to combustibles:
 For Single Wall vents 6 inches (6 po),
 For Type B-1 vent type 1 inch (1 po).

MINIMUM INCHES CLEARANCE TO COMBUSTIBLE CONSTRUCTION

DOWNFLOW POSITIONS:

- † Installation on non-combustible floors only.
 For Installation on combustible flooring only when installed on special base, Part No. KGASB0201ALL or NAHA01101SB, Coil Assembly, Part No. CAR, CAP, CNPV, CNRV, END4X, ENW4X, WENC, WTNC, WENW OR WTNW.
- Ø 18 inches front clearance required for alcove.
- * Indicates supply or return sides when furnace is in the horizontal position. Line contact only permissible between lines formed by intersections of the Top and two Sides of the furnace jacket, and building joists, studs or framing.



336996-101 REV. C

A10269



ISO 9001
QMI-SAI Global



Use of the AHRI Certified™ Mark indicates a manufacturer's participation in the program. For verification of certification for individual products, go to www.ahridirectory.org.



**Always Ask For
FACTORY
AUTHORIZED
PARTS**

SPECIFICATIONS

UNIT SIZE		036045	036070	048070	042090	048090	060090	060110	060135
RATINGS AND PERFORMANCE									
Input Btuh*	Upflow	44,000	66,000	66,000	88,000	88,000	88,000	110,000	132,000
	Downflow/Horizontal	42,000	63,000	63,000	84,000	84,000	84,000	105,000	126,000
Output Capacity (Btuh)†	Upflow;	36,000	54,000	54,000	71,000	72,000	72,000	90,000	107,000
	Downflow/Horizontal	34,000	51,000	51,000	68,000	68,000	68,000	85,000	102,000
AFUE‡		80.0	80.0	80.0	80.0	80.0	80.0	80.0	80.0
Certified Temperature Rise Range – °F (°C)		30-60 (17–33)	35–65 (19–36)	25–55 (14–31)	40-70 (22–39)	35–65 (19–36)	35–65 (19–36)	30-60 (17–33)	40-70 (22–39)
External Static Pressure	Heating	0.10	0.12	0.12	0.15	0.15	0.15	0.20	0.20
	Cooling	0.50	0.50	0.50	0.50	0.50	0.50	0.50	0.50
Airflow CFM‡	Heating	710	982	1205	1203	1418	1650	1890	1760
	Cooling	1080	1005	1435	1210	1445	1980	2040	1810
ELECTRICAL									
Unit Volts—Hertz—Phase		115-60-1							
Operating Voltage Range Min-Max		104-127							
Maximum Unit Amps		5.6	5.6	10.0	8.2	8.2	12.9	13.4	10.7
Unit Ampacity		7.8	7.8	13.3	11.0	11.0	16.9	17.4	14.0
Maximum Wire Length (Measure one way in Ft (M))		47 (14.3)	47 (14.3)	27 (8.2)	33 (10.1)	33 (10.1)	33.9 (10.3)	33 (10.1)	26.0 (7.9)
Minimum Wire Size		14					12		14
Maximum Fuse or Ckt Bkr Size (Amps)**		15					20		15
Transformer (24v)		40va							
External Control Heating		12va							
Power Available Cooling		35va							
Air Conditioning Blower Relay		Standard							
CONTROLS									
Limit Control		SPST							
Heating Blower Control		Solid-State Time Operation							
Burners (Monoport)		2	3	3	4	4	4	5	6
Gas Connection Size		1/2-in. NPT							
GAS CONTROLS									
Gas Valve (Redundant)	Mfr.	White-Rodgers							
	Min. inlet pressure (In. W.C.)	4.5/1.21 (Natural Gas)							
	Max. inlet pressure (In. W.C.)	13.6/3.386 (Natural Gas)							
Ignition Device		Hot Surface							
Factory-installed orifice		Size 43							
BLOWER DATA									
Direct-Drive Motor HP (ECM)		1/3	1/3	3/4	1/2	1/2	1	1	3/4
Motor Full Load Amps		4.4	4.4	8.8	6.8	6.8	11.5	11.5	8.8
RPM (Nominal)-Speeds		1050–5							
Blower Wheel Diameter x Width – In. (mm)		10 x 6 (254 x 152)	11 x 8 (279 x 203)	11 x 8 (279 x 203)	11 x 8 (279 x 203)	10 x 10 (254 x 254)	11 x 11 (279 x 279)	11 x 11 (279 x 279)	11 x 11 (279 x 279)

* Gas input ratings are certified for elevations to 2000 ft. (610 M). In USA, for elevations above 2000 ft. (610 M), reduce ratings 4 percent for each 1000 ft. (305 M) above sea level. Refer to National Fuel Gas Code NFPA 54/ANSI Z223.1–2012 Table F.4 or furnace installation instructions.

† Capacity in accordance with U.S. Government DOE test procedures.

‡ Airflow shown is for bottom only return-air supply for the as-shipped speed tap. For air delivery above 1800 CFM, see Air Delivery table for other options. A filter is required for each return-air supply. An airflow reduction of up to 7 percent may occur when using the factory-specified 4-5/16 in. wide, high efficiency media filter.

** Time–delay type is recommended.

ICS Isolated Combustion System

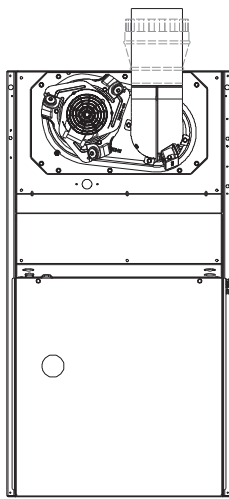

SEE NOTES: 1,2,4,7,8,9
UPFLOW
A02058

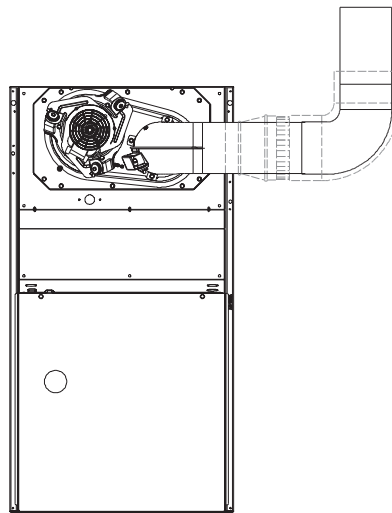

SEE NOTES: 1,2,3,4,7,8,9
UPFLOW
A02059

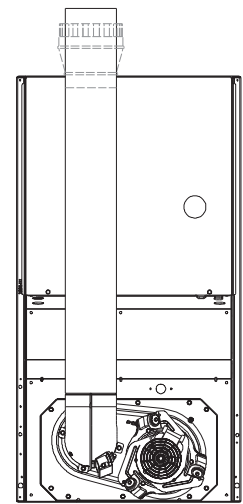

SEE NOTES: 1,2,4,5,7,8,9
DOWNFLOW
A02061

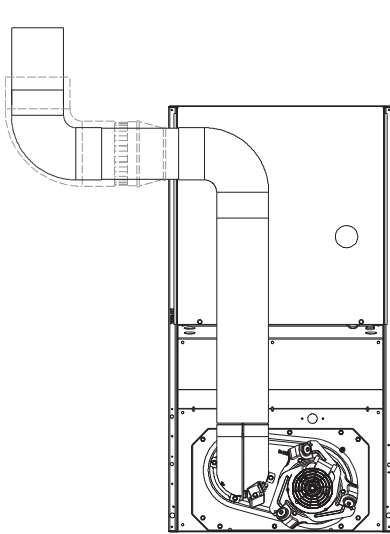

SEE NOTES: 1,2,3,4,5,7,8,9
DOWNFLOW
A02060

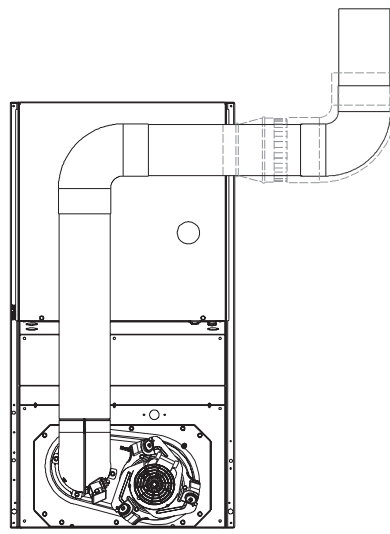

SEE NOTES: 1,2,3,4,7,8,9
DOWNFLOW
A02063

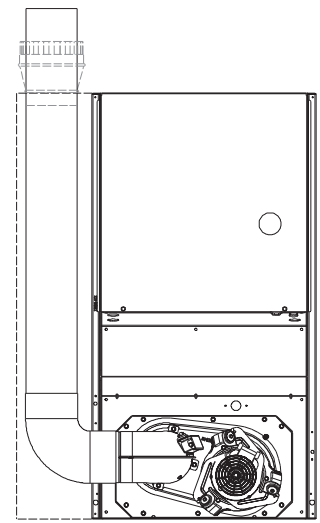

SEE NOTES: 1,2,4,5,6,7,8,9
DOWNFLOW
A02062

Venting Notes

1. For common vent, vent connector sizing and vent material: United States, latest edition of the National Fuel Gas Code (NFPA54/ANSI Z223.1).
2. Immediately increase to 5-in. (127 mm) vent connector outside furnace casing when 5-in. (127 mm) vent connector required, refer to Note 1.
3. Side outlet vent for upflow and downflow installations must use Type B vent immediately after exiting the furnace, except when accessory Downflow Vent Guard is used in downflow position.
4. Type B vent where required, refer to Note 1.
5. 4-in. (102 mm) single wall vent must be used inside furnace casing and the Downflow Vent Guard Kit.
6. Accessory Downflow Vent Guard Kit required in downflow installations with bottom vent configuration.
7. Chimney Adapter Kit required for exterior masonry chimney applications. Refer to Chimney Adapter Kits for sizing and complete application details.
8. Secure vent connector to furnace elbow with (2) corrosion-resistant sheet metal screws, space approximately 180° apart.
9. Secure all other single wall vent connector joints with (3) corrosion-resistant screws spaced approximately 120° apart. Secure Type B vent connectors per vent connector manufacturer's recommendations.

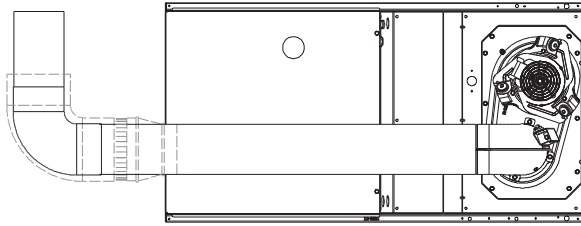

SEE NOTES: 1,2,4,5,7,8,9
HORIZONTAL RIGHT

A02068

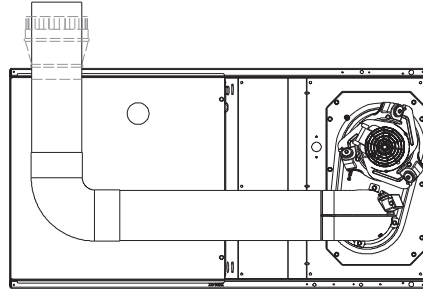

SEE NOTES: 1,2,4,5,7,8,9
HORIZONTAL RIGHT

A02070

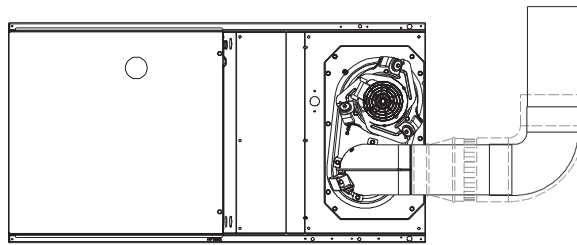

SEE NOTES: 1,2,4,7,8,9
HORIZONTAL RIGHT

A02069

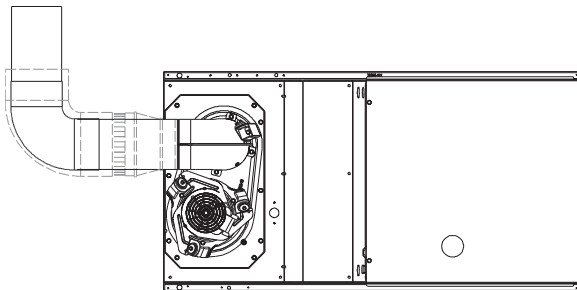

SEE NOTES: 1,2,4,7,8,9
HORIZONTAL LEFT

A02064

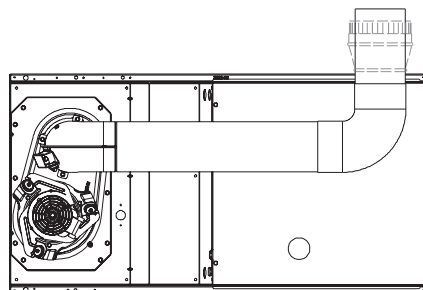

SEE NOTES: 1,2,4,5,7,8,9
HORIZONTAL LEFT

A02065

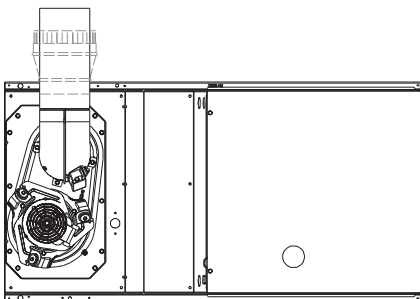

SEE NOTES: 1,2,4,5,7,8,9
HORIZONTAL LEFT

A02066

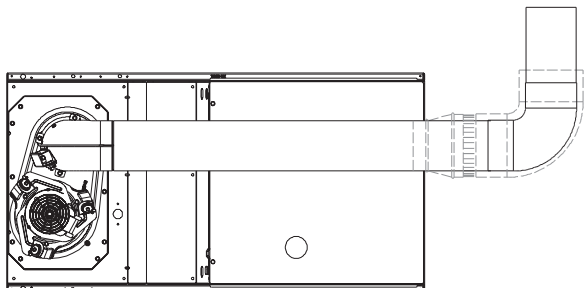

SEE NOTES: 1,2,4,5,7,8,9
HORIZONTAL LEFT

A02067

ACCESSORIES

DESCRIPTION	PART NO.	036045	036070	048070	042090	048090	060090	060110	060135
Media Filter Cabinet	FILCABXL0016	X	X	X	X				
	FILCABXL0020					X	X	X	
	FILCABXL0024								X
Cartridge Media Filter	FILCCCAR0016	X	X	X	X				
	FILCCCAR0020					X	X	X	
	FILCCCAR0024								X
EZ Flex Media Filter with End Caps	EXPXXUNV0016	X	X	X	X				
	EXPXXUNV0020					X	X	X	
	EXPXXUNV0024								X
Replacement EZ Flex Filter Media	EXPXXFIL0016	X	X	X	X				
	EXPXXFIL0020					X	X	X	
External Bottom Return Filter Rack	KGBFR0401B14	X							
	KGBFR0501B17		X	X	X				
	KGBFR0601B21					X	X	X	
	KGBFR0701B24								X
External Side Return Filter Rack	KGAFR0201ALL	X	X	X	X	X	X	X	X
Unframed Filter 3/4-in. (19 mm)	KGAWF1306UFR †	X	X	X	X				
	KGAWF1406UFR					X	X	X	
	KGAWF1506UFR								X
Flue Extension	KGAFE0112UPH	X	X	X	X	X	X	X	X
Combustible Floor Base	KGASB0201ALL	X	X	X	X	X	X	X	X
Downflow Vent Guard	KGBVG0101DFG	X	X	X	X	X	X	X	X
Vent Extension Kit	KGAVE0101DNH	X	X	X	X	X	X	X	X
Chimney Adapter Kit	KGACA02014FC	X	X	X	X	X	X	X	
Chimney Adapter Kit	KGACA02015FC								X
Natural-to-Propane Conversion Kit*	KGBNP50011SP	X	X	X	X	X	X	X	X
Propane-to-Natural Conversion Kit*	KGBPN42011SP	X	X	X	X	X	X	X	X
Gas Orifice	LH32DB207	See Installation Instructions for model, altitude, and heat value usages.							
	LH32DB202								
	LH32DB200								
	LH32DB205								
	LH32DB208								
	LH32DB078								
	LH32DB076								
	LH32DB203								
	LH32DB201								
	LH32DB206								
	LH32DB209								
	LH32DB210								

*Factory—authorized and field—installed. Gas conversion kits are CSA (AGA/CGA) recognized.

†Suitable for Side Return Filter Rack.

X – Accessory

S – Standard

CONTROLS – THERMOSTAT & ZONING

ACCESSORIES	
ELECTRONIC AIR CLEANER (EAC)	Model EACB
AIR PURIFIER	Models GAPAAXBB1625, GAPAAXBB2025
MECHANICAL AIR CLEANER	Models EZXCAB, FILCAB
HUMIDIFIER	Model HUM
HEAT RECOVERY VENTILATOR	Model HRV
ENERGY RECOVERY VENTILATOR	Model ERV
UV LIGHTS	Model UVL
THERMOSTAT – NON-PROGRAMMABLE	For use with 1-speed Air Conditioner – deg. F/C, Auto Changeover – T6-NAC, T2-NAC
	For use with 1-speed Heat Pump – deg. F/C, Auto Changeover – T6-NHP, T2-NHP*
THERMOSTAT – PROGRAMMABLE	For use with 1-speed Air Conditioner – deg. F/C, Auto Changeover, 7-Day Programmable – T6-PAC
	For use with 1-speed Heat Pump – deg. F/C, Auto Changeover, 7-Day Programmable – T6-PHP*
	For use with 1-speed Air Conditioner – deg. F/C, 5-2 Day Programmable – T6-PAC
ZONING CONTROL	Zone Perfect 3-Zone kit – ZONEBB3ZAC01, ZONEBB3ZHP01
	2-Zone Perfect Plus kit/Temperature and Humidity Control – ZONEBB2KIT01-B
	4-Zone Perfect Plus kit/Temperature and Humidity Control – ZONEBB4KIT01-B
	8-Zone Perfect Plus kit/Temperature and Humidity Control – ZONEBB8KIT01-B

*Model HP and 2S thermostat must be field converted to air conditioner operation.

†Thermidistat™ Control can be configured for multiple use and staging. It must be configured for each specific application.

‡Dual Fuel thermostat is used with furnace and heat pump application.

MODEL NUMBER NOMENCLATURE

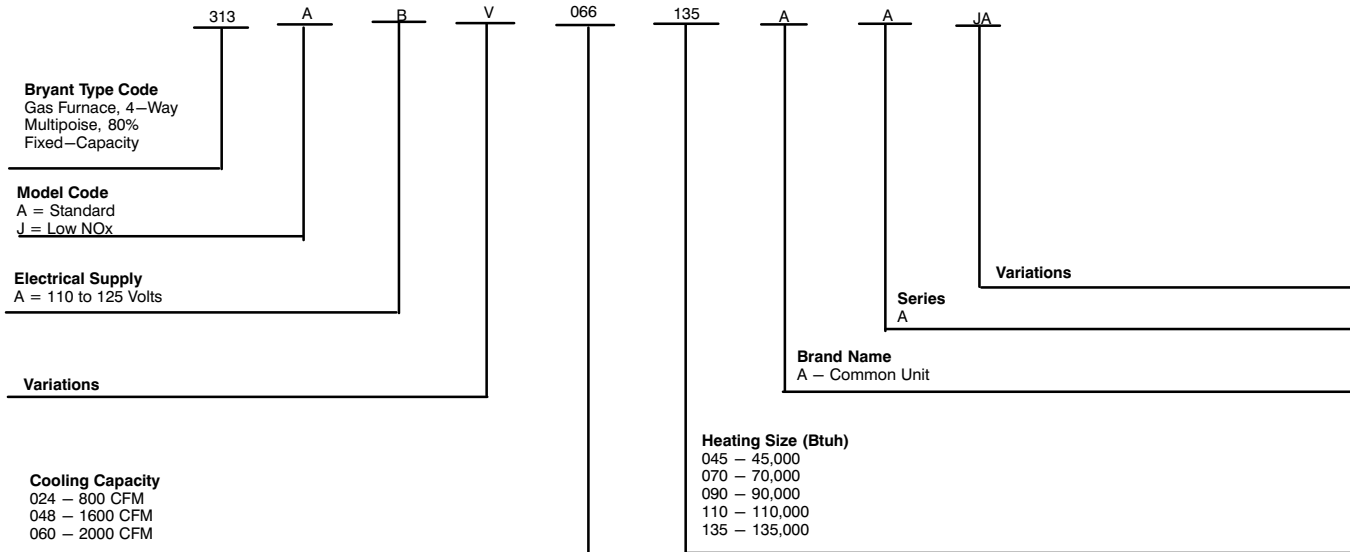

TYPICAL WIRING SCHEMATIC

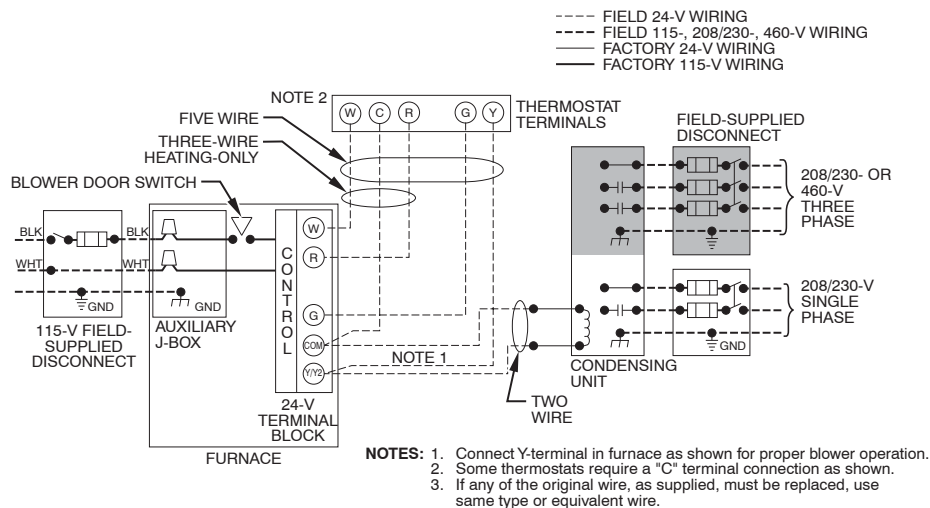

*Model HP and 2S thermostat must be field converted to air conditioner operation.

†Thermidistat™ Control control can be configured for multiple use and staging. It must be configured for each specific application.

‡Dual Fuel thermostat is used with furnace and heat pump application.

AIR DELIVERY – CFM (WITH FILTER)*

Furnace	Wire Lead Color	Speed	Test Airflow Delivery @ Various External Static Pressures									
			0.1	0.2	0.3	0.4	0.5	0.6	0.7	0.8	0.9	1
036045	Gray	5	1230	1190	1155	1120	1080	1045	1010	975	935	895
	Yellow	4	980	945	920	890	855	815	770	735	690	645
	Orange	3	770	720	685	640	600	560	520	475	430	385
	Blue	2	710	660	620	580	540	490	455	415	375	335
	Red	1	600	540	500	455	415	385	345	305	235	--
036070	Gray	5	1185	1140	1095	1055	1005	960	915	865	820	780
	Yellow	4	1000	940	895	850	800	750	695	650	600	555
	Blue	3	990	935	895	845	790	740	690	640	590	535
	Orange	2	855	775	720	660	605	560	495	435	385	335
	Red	1	860	685	515	445	385	340	275	205	--	--
048070	Gray	5	1610	1565	1525	1475	1435	1395	1350	1305	1260	1215
	Yellow	4	1385	1335	1290	1250	1205	1165	1125	1075	1025	980
	Blue	3	1215	1165	1120	1075	1035	985	940	895	845	840
	Orange	2	1175	1130	1085	1035	990	945	900	855	805	760
	Red	1	1080	1015	955	920	875	820	780	725	670	620
042090	Gray	5	1355	1320	1285	1245	1210	1165	1125	1080	1025	815
	Yellow	4	1295	1255	1220	1185	1140	1100	1055	1005	955	815
	Blue	3	1220	1185	1150	1105	1065	1025	975	915	840	740
	Orange	2	1030	985	940	900	845	790	715	655	590	535
	Red	1 ³	945	905	855	800	750	670	600	540	490	435
048090	Gray	5	1625	1580	1535	1490	1445	1395	1340	1260	1135	995
	Blue	4	1440	1395	1350	1305	1255	1200	1145	1090	1040	950
	Yellow	3	1425	1380	1335	1290	1235	1185	1125	1075	1020	940
	Orange	2	1260	1210	1160	1105	1050	990	935	880	820	755
	Red	1 ³	1095	1040	980	905	845	780	720	650	585	520
060090	Gray	5	2180	2130	2080	2030	1980	1925	1870	1805	1745	1680
	Yellow	4	1900	1845	1795	1740	1685	1635	1570	1500	1435	1375
	Blue	3	1685	1620	1565	1505	1455	1385	1320	1260	1200	1140
	Orange	2	1390	1315	1240	1175	1095	1030	970	900	825	760
	Red	1 ³	1240	1155	1075	990	915	835	765	690	615	555
060110	Gray	5	2255	2205	2150	2100	2040	1985	1920	1835	1735	1615
	Blue	4	1945	1890	1830	1770	1715	1655	1600	1545	1480	1430
	Yellow	3	1600	1525	1465	1400	1335	1275	1210	1150	1080	1015
	Orange	2	1420	1340	1280	1200	1140	1065	1005	925	865	790
	Red	1	1280	1205	1140	1055	990	910	840	760	695	630
060135	Gray	5	2065	2005	1940	1875	1810	1740	1670	1600	1530	1470
	Blue	4	1825	1760	1695	1630	1560	1490	1420	1350	1275	1205
	Yellow	3	1760	1690	1625	1555	1485	1415	1345	1275	1200	1130
	Orange	2	1620	1550	1480	1405	1335	1260	1195	1130	1065	995
	Red	1 ³	1325	1260	1185	1100	1025	955	885	805	735	670

1. A filter is required for each return–air inlet. Airflow performance included 3/4–in. (19 mm) washable filter media such as contained in factory–authorized accessory filter rack. To determine airflow performance without this filter, assume an additional 0.1 In. W.C. available external static pressure.

2. **Adjust the blower speed tabs as necessary for the proper air temperature rise for each installation.**

3. Highlighted areas indicate airflow range is beyond the range allowed for heating. **THESE AIRFLOW RANGES MAY ONLY BE USED FOR COOLING.**

4. -- Indicates unstable operating conditions.

GUIDE SPECIFICATIONS

Gas Furnace

313ABV/JBV

GENERAL

System Description

Furnish a _____ fixed capacity gas-fired furnace for use with natural gas or propane (factory authorized conversion kit required for propane); furnish cold air return plenum.

Quality Assurance

Unit will be designed, tested and constructed to the current ANSI Z 21.47/CSA 2.3 design standard for gas-fired central furnaces.

Unit will be 3rd party certified by CSA to the current ANSI Z 21.47/CSA 2.3 design standard for gas-fired central furnaces.

Unit will carry the CSA Blue Star® label.

Unit efficiency testing will be performed per the current DOE test procedure as listed in the Federal Register.

Unit will be certified for capacity and efficiency and listed in the latest AHRI Consumer's Directory of Certified Efficiency Ratings.

Unit will carry the current Federal Trade Commission Energy Guide efficiency label.

Delivery, Storage and Handling

Unit shall be shipped as single package only and is stored and handled per unit manufacturer's recommendations.

Warranty (for inclusion by specifying engineer)

U.S. only. Warranty certificate available upon request.

PRODUCTS

Equipment

Components shall include: slow-opening gas valve to reduce ignition noise, regulate gas flow, with electric switch gas shut-off; flame proving sensor, hot surface igniter, pressure switch assembly; flame rollout switch, blower and inducer assembly, 40va transformer; low-voltage (heating) (heating/ cooling) thermostat.

Blower Wheel and Blower Motor

Galvanized blower wheel shall be centrifugal type, statically and dynamically balanced. Blower motor of ECM type shall be permanently lubricated with sealed bearings, of _____ hp, and shall be multiple-speed direct drive. Blower motor shall be soft mounted to the blower scroll to reduce vibration transmission.

Filters

Furnace may have reusable-type filters. Filter shall be _____ in (x) _____ in. (mm). An accessory high-efficiency media filter is available as an option. _____ Media Filter.

Casing

Casing shall be of .030 in. (.76 mm) thickness minimum, pre-painted steel.

Inducer Motor

Inducer motor shall be soft mounted to reduce vibration transmission.

Draft Safeguard Switch

Draft Safeguard Switch (blocked vent safeguard) shall be factory installed to reduce the possibility of vent gas infiltration due to a blocked or restricted vent pipe.

Heat Exchangers

Heat exchangers shall be a 4-Pass 20 gage aluminized steel of fold-and-crimp sectional design when applied operating under negative pressure.

Controls

Control shall include a micro-processor based integrated electronic control board with at least 11 service troubleshooting codes displayed via enhanced flashing LED diagnostic light on the control, a self-test feature that checks all major functions of the furnace within one minute, and a replaceable automotive-type circuit protection fuse. Multiple operational settings available including separate blower speeds for heating and cooling.

Operating Characteristics

Heating Capacity shall be _____ Btuh input; _____ Btuh output capacity.

Fuel Gas Efficiency shall be 80% AFUE.

Air delivery shall be _____ CFM minimum at 0.50 In. W.C. external static pressure.

Dimensions shall be: depth _____ in.; width _____ in.; height _____ in. (mm) (casing only). Height shall be _____ in. (mm) with A/C coil and _____ in. (mm) overall with plenum.

Electrical Requirements

Electrical supply shall be 115 volts, 60 Hz, single-phase (nominal). Minimum wire size shall be _____ AWG; maximum fuse size or circuit breaker shall be _____ Amps.

Special Features

Refer to section of the product data sheet identifying accessories and descriptions for specific features and available enhancements.